

# ESB001

## Inrush Current Limiter, Inrush Current Protection

For capacitive loads, 230Vac 16A, 16 ⅓ Hz – 440Hz, - 40°C ... +55°C

### Short Specification:

- Peak- / R.M.S. inrush current limiter
- 184-264Vac, 16A continuous
- Power consumption 1,1W @ 230Vac
- DIN TS35mm DIN-Rail
- Wall mount (universal case)
- Spring-type terminals 4mm<sup>2</sup> / 12AWG
- Integrated bypass relay
- Capacitive load 2.200uF & 5.000uF
- Integrated thermal protection
- IP20 UL94V-0 case DIN43880 for DIN/VDE0603 cutout box
- EN62368-1, EN55032 class B

The ESB001 is a budget-priced inrush peak current limiter for high loads in LED-applications, complex automation systems and in the machine building. The ESB001 offers effective and interference free operation with capacitive loads. It is simple to integrate into existing equipment. The ESB001 is self-powering and does not require an external power supply.

## 16 ⅓ Hz – 440Hz

**No simple NTC-solution! It allows to reduce cabling sections and to install fast circuit breakers. 100% protection from tripping pre-installed circuit breakers or burning relay and line switch contacts.**



<b>Technical Table</b>		
Model	ESB001.24.230VAC	ESB001.LED.230VAC
Peak Current Limiting $\pm 6\%$	24A	43A
R.M.S Current Limiting $\pm 6\%$	17A	30,1A
Maximum Allowed Capacitive Load	2.200uF	5.000uF
Limiting Time ( $T_{on}$ Power On)	250ms ( $\pm 50$ ms)	250ms ( $\pm 50$ ms)
Release Time ( $T_{off}$ Low Voltage)	500ms ( $\pm 50$ ms)	500ms ( $\pm 50$ ms)
Limiting Interval [ $T_{interval}$ for AC <sub>cont.</sub> ]	$\geq 1000$ ms	$\geq 1000$ ms
Advisable Circuit breaker at 30°C	B6A – B16A	B13A – B16A
AC Input Range	184-264Vac	
AC Continuous Input Range	230Vac	
Line Frequency	16 ½ Hz – 440Hz	
Switch-On Voltage	144Vac	
AC Lower Margin	52Vac (AC dump / drop out voltage)	
AC Current	16A continuous load current	
Power Supply	No external power supply required, item is self-powering	
Power consumption	1,1W @ 230Vac	
Limiting Cycles	Between each limiting action shall be a break of 20 sec., to let the device cool down until the next limiting starts	
Internal Protection	Thermal fuse protects from overheat & fire	
Cooling	Natural convection	
Operation Temp.	Ambient temperature -40°C ... +55°C continuous (see operations temperature list for details in this manual)	
Storage Temp.	-40°C ... +85°C for 2 years	
EMI	EN55032 class B, EN61000-6-3	
EMS	EN61000-6-2	
Safety Norms	EN61010-1, EN61010-2-201, EN62368-1, EN60950-1 applicable	
Safety Class	Class II	
ROHS conformity	ROHS Directive 2011/65/EU	
REACH conformity	REACH Directive 1907/2006	
MTBF Calculation	380.000h (IEC/EN61709, Siemens SN29500)	
MTTF Calculation	412.000h (+30°C) (IEC/EN61709, Siemens SN29500)	
Humidity	95% (+25°C) not condensing	
Pollution Degree	2 (IEC/EN50178)	
Environmental	Thermal environment 3K3, mechanics 3M4 (IEC/EN60721)	
Altitude max.	4000m (13123 ft.) above sea level	
Dimensions (WxHxD)	(Wide=1TE), 17,9x89,5x62,8mm	
Housing Parameters	UL94V-0 housing for DIN/VDE0603 cutout box	
DIN-Rail	DIN-Rail TS35mm DIN/EN60715 (TS35/7,5 und TS35/15)	
Weight	0,07kg / 0,15lbs	
Connections	Spring-type terminal block solid max. 0,13...4mm <sup>2</sup> 26...12AWG according with IEC/EN60664-1, IEC/EN61984 Use copper conductors only. Wire stripping length 6mm. Tightening torque per terminal block is 0.5 - 0.6 Nm / 4.5 - 5.3 lbf-in	

## General Description

The CAMTEC ESB001-series are the 3rd generation of cost-effective inrush current limiters. The limiters are made for 230Vac 16A networks. The line frequency range is 16½Hz – 440Hz. The ESB001-Limiter shall be located between the line-switcher/contactator and the load (Fig.1). The ESB-models are designed for capacitive loads (not for inductive loads like coils/transformers, not for AC-motors and not for DC-voltage application). In the moment of switching-on the system the inrush current of the installed load will be limited for the defined time  $T_{on}$  (Fig.4). Note that the inrush current limiting of the ESB is not affected by the inrush level of the load. The inrush limiting level of the ESB001 has always priority to the inrush level generated by the load. After  $T_{on}$  elapses the current limiting circuit of the ESB001 will be bypassed. Then the load is directly connected to the AC network. If an AC dip overshoots the defined time  $T_{off}$ , it will be detected by the ESB001 (Fig.5). As soon as the AC recovers the inrush will be limited, again (Fig.2 & 3). The ESB001-models provide an internal temperature control. In case of a failure the device shuts down to safely prevent from overheating or fire.

Although the ESB001 detects an AC dip, it does not have an intelligent measuring circuit. Therefore, in bypass mode, the ESB001 cannot detect current coming from the connected load. The ESB001 must be switched on together with the load to be effective.

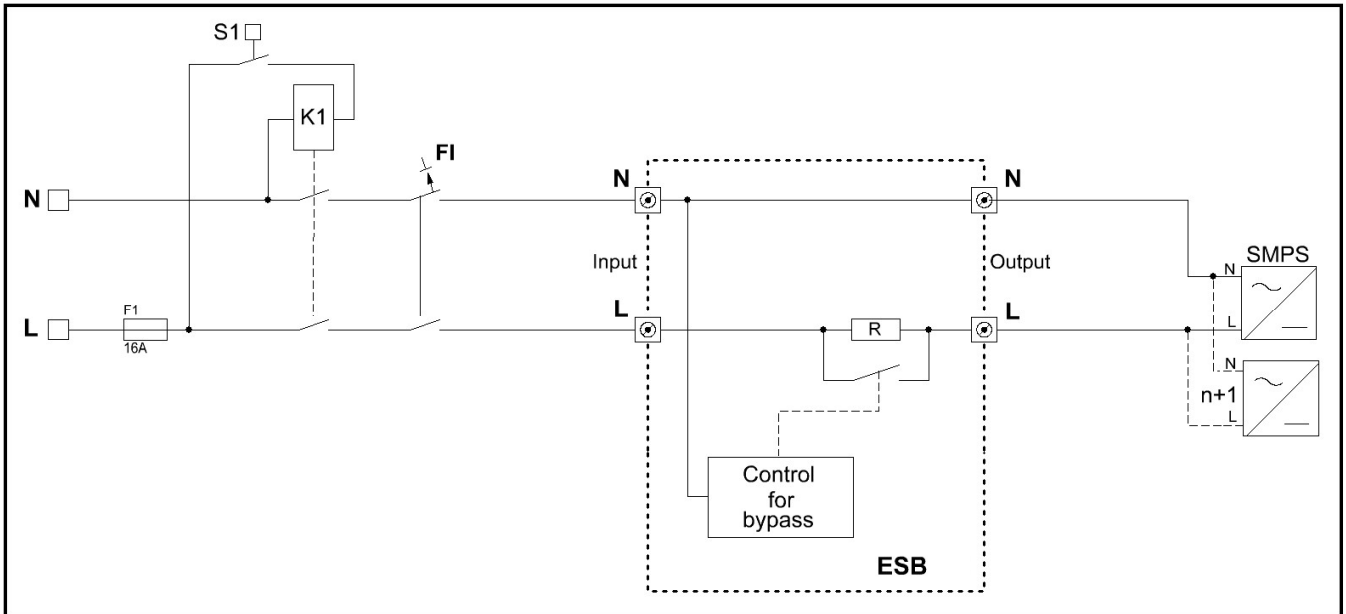

(Fig.1)

### Field Applications

The ESB001 limiter enables the connection of significantly more capacitive loads (e.g. LED power supplies / LED drivers) to a pre-installed circuit breaker CB (Fig.1). The ESB prevents the MCB from being tripped. This happens independently of the targeted output current. As a result, the number of AC feeders and the pre-installed MCB can be drastically reduced. The installation costs are reduced in the long term. Alternatively, the cross-section of the branch circuits can be reduced if smaller and faster-responding circuit breakers are used. The cost savings in copper are substantial. Sensitive AC networks can be protected more safely (e.g. traffic control systems, street lighting, parking lots and tunnels). When the ESB001 is installed correctly, the neutral conductor (N) is looped through (Fig.1). The switch-on protection circuit always acts on the line conductor. The load refers to the AC current in such a way that a circuit breaker or a residual current circuit breaker operates within the limits of the legal regulations. This also applies to the response of the limiting circuit. The ESB001 is designed for capacitive loads only. The ESB001 cannot be used together with transformers, coils, AC motors and drives, heaters, resistive loads or with DC voltage or with gas induction lamps.

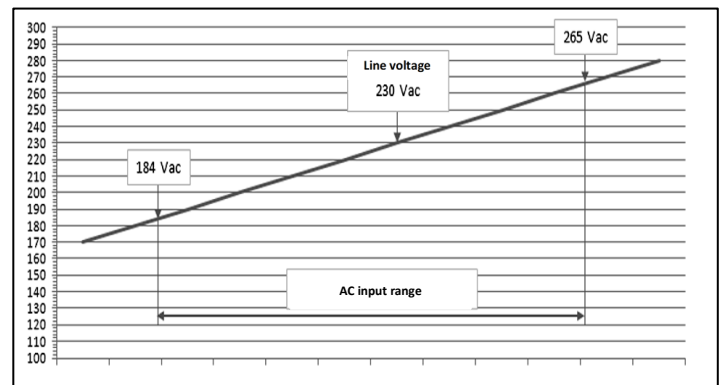

(Fig.2 operating range 230Vac)

**Design-In of the ESB001 into A/C networks**

The ESB001 models are the precise inrush current limiters with an overall tolerance of  $\pm 6\%$  of the rated value. For the sizing of an upstream circuit breaker, the R.M.S. is the key value of the inrush current, not the peak current. The thermal trip point is not reached even when a fast circuit breaker is used. The magnetic trip current is the decisive factor. Using the empirical formula  $I(\text{peak}) \times 0.707(\text{factor}) = I(\text{r.m.s.})$ , the tripping current can be accurately determined. It should be noted that the higher the inrush current, the faster the input capacitor is loaded by several connected switching power supplies. The technical table on page 2 shows the RMS value of all ESB001 types and models.

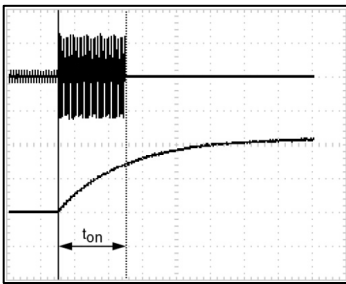

(Fig.4 limiting time  $T_{on}$ )

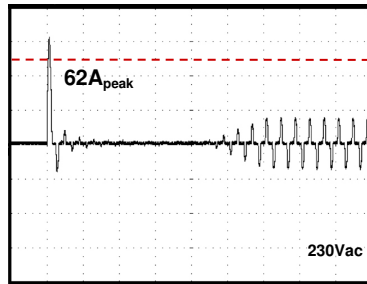

(Fig.5 AC dump detection  $T_{off}$ )

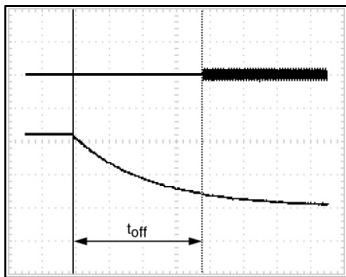

(Fig.6 AC dump detection  $T_{off}$ )

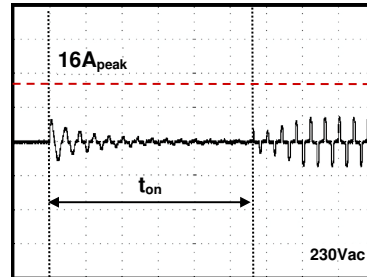

(Fig.7 inrush with ESB001)

Fig.5 and Fig.7

Fig.5 and Fig.7 show the typical start behavior of an NTC-protected switch mode power supply as an empirical example.

The peak current records show the precise limitation of the inrush current from the former 62A<sub>peak</sub> to 16A<sub>peak</sub>. The corresponding R.M.S. level responsible for magnetic circuit breaker (MCB) tripping is reduced by a factor of 0.707. After the time  $T_{one}$  has elapsed, the power supply transitions cleanly to continuous operation. Now the current is absorbed from the AC supply in a pulsed manner. The full-load RMS current draw of the example power supply reaches 9.8A at 230Vac.

**Mechanics**

IP20 housing, UL94V-0 ABS housing for DIN/VDE0603 cutout box and wall mount. DIN 43880 with IEC standardized ventilation slots. Save fix on DIN-Rail TS35mm (7.5/15) DIN/EN60715. It is designed for building cabinets DIN/VDE0603.

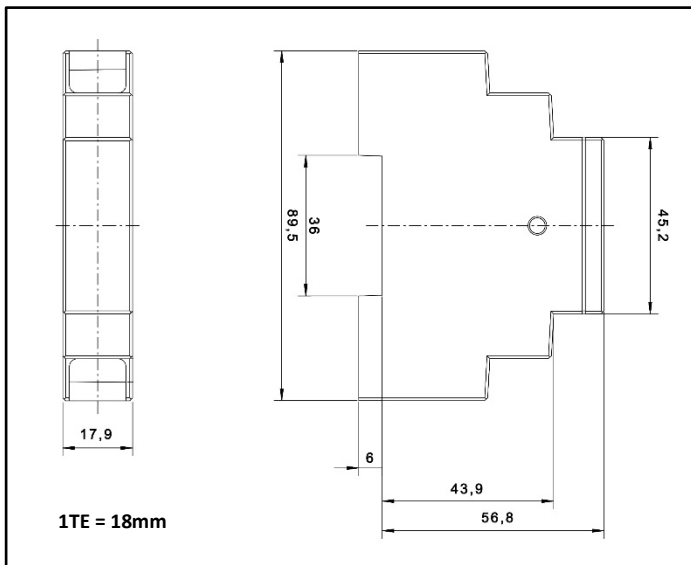

(Fig.8 mechanical dimensions)

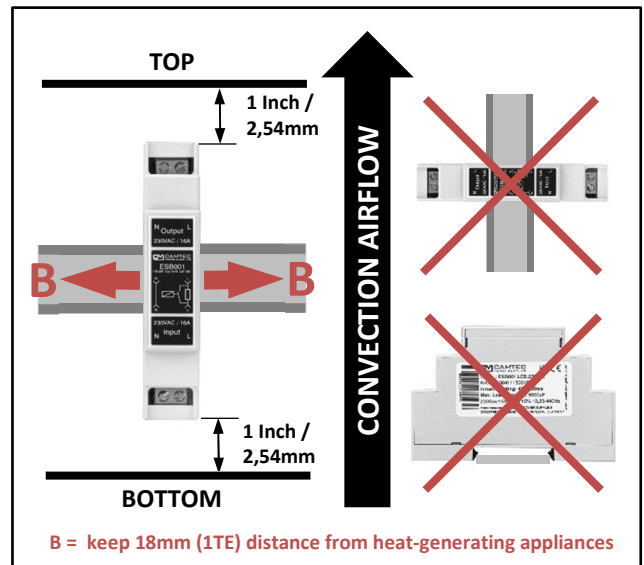

(Fig.9 mounting direction & distances)

## Connections

### Clamping Yoke Connector Specifications

	Input / Output connections
Tightening torque min. – max.	0,5 – 0,6 Nm (blade 0,5x3,5 DIN5264 )
Clamping range, min. – max.	0,2 – 4,0 mm <sup>2</sup> / AWG24 – AWG12
Solid, H05(07) V-U min. – max.	0,2 – 2,5 mm <sup>2</sup>
Stranded, H05(07) V-U min. – max.	0,2 – 2,5 mm <sup>2</sup>
w. plastic collar ferrule, DIN 46228 pt 4 min. – max.	0,25 – 2,5 mm <sup>2</sup>
w. wire end ferrule, DIN 46228 pt 1, min. – max.	0,25 – 2,5 mm <sup>2</sup>
Pitch (P)	5,08mm

### Wire Stripping Length (fine wired)

Nominal Cross Section	Wire End Ferrule	Stripping Length
0,5mm <sup>2</sup>	H0,5/6	6mm
0,75mm <sup>2</sup>	H0,75/6	6mm
1,0mm <sup>2</sup>	H1,0/6	6mm
2,5mm <sup>2</sup>	H2,5/7	7mm

The length of ferrules is to be chosen depending on the rated voltage. The outside diameter of the plastic collar should not be larger than the pitch (P)

### Mounting Instructions

Follow the above mounting restrictions to allow maximum lifetime of the product and to prevent from tripping the internal temperature protection fuse. The ESB001 is an active device. The distance between an ESB001 and the next active or temperature sensitive device shall be 17,5mm or larger. The power consumption of the device is constant at continuous operation (1,1W @ 230Vac). Make sure that the ventilation holes below and above the unit are not blocked to allow free air convection.

Operation Temperature	Ambient Temperature	ESB001, 230Vac, AC 10A current	IEC EN61010-1	-40°C ... +55°C
			IEC EN61010-2-201	-40°C ... +55°C
		ESB001, 230Vac, AC 16A current	IEC EN62368-1	-40°C ... +55°C
			IEC EN60950-1	-40°C ... +55°C
			IEC EN61010-1	-40°C ... +50°C
			IEC EN61010-2-201	-40°C ... +50°C
			IEC EN62368-1	-40°C ... +50°C
			IEC EN60950-1	-40°C ... +50°C

### Table of the standards

Product Code	Article No.	IEC / EN 62368-1	IEC / EN61010-2-201	IEC / EN 61010-1	IEC / EN 60950-1
ESB001.24.230VAC	3041081001CA	Yes	Yes	Yes	Yes
ESB001.LED.230VAC	3041081002CA	Yes	Yes	Yes	Yes



**Safety regulations: Please read these instructions completely before using the equipment. Keep these instructions on to hand. The device may only be installed by trained specialist staff.**

**Installation:**

- 1) The device is designed for devices and systems that meet the standard requirements for hazardous voltages, power, and fire prevention.
- 2.) Installation and service only by trained persons. The AC power must be switched off. The work is to be labelled; accidental reconnection of the system must be prevented.
- 3.) Opening the device, its modification, loosening bolts, or operation outside the specified herein specification or in an unsuitable environment, has the immediate loss of warranty to follow. We disclaim any responsibility for any resulting damage to persons or things.
- 4.) Note: The device must not be operated without an upstream circuit breaker (CB). The CB must not be larger than 16A.

**Warning:**

**Non-compliance these warnings can result in fire and serious injury or death.**

1. Before connecting the device to the AC network, make wires free of voltage and assure accidentally switch on.
2. Allow neat and professional cabling.
3. Never open nor try to repair the unit. Inside are dangerous voltages that can cause electrical shock hazard.
4. Avoid metal pieces or other conductive material to fall into the item.
5. Do not operate the device in damp or wet conditions
6. Do not operate the unit under EX-conditions.
7. Do not operate the unit with then capacitive load.





<p><b>English Installation instruction</b></p>	<p><b>Read this first!</b> Before operating this device, please read this manual thoroughly and retain this manual for future reference! This device may only be installed and put into operation by qualified personnel. If damage or malfunction should occur during operation, immediately turn power off and send device to the factory for inspection. The device does not contain serviceable parts. The information presented in this document is believed to be accurate and reliable and may change without notice. For any clarifications, the English translation will be used.</p> <p><b>WARNING Risk of electrical shock, fire, personal injury, or death:</b></p> <ul style="list-style-type: none"> <li>- Turn power off before working on the device. Protect against inadvertent re-powering.</li> <li>- Do not open, modify, or repair the device.</li> <li>- Use caution to prevent any foreign objects from entering the housing.</li> <li>- Do not use in wet locations or in areas where moisture or condensation can be expected.</li> <li>- Do not touch during power-on and immediately after power-off. Hot surfaces may cause burns.</li> </ul>
<p><b>Deutsch Installations- anweisung</b></p>	<p><b>Vor der Inbetriebnahme lesen!</b> Bitte lesen Sie diese Warnungen und Hinweise sorgfältig durch, bevor Sie das Gerät in Betrieb nehmen. Bewahren Sie die Anleitung zum Nachlesen auf. Das Gerät darf nur durch fachkundiges und qualifiziertes Personal installiert werden. Bei Funktionsstörungen oder Beschädigungen schalten Sie sofort die Versorgungsspannung ab und senden das Gerät zur Überprüfung ins Werk. Das Gerät beinhaltet keine Servicebauteile. Die angegebenen Daten dienen allein der Produktbeschreibung und sind nicht als zugesicherte Eigenschaften im Rechtsinne aufzufassen. Im Zweifelsfall gilt der englische Text.</p> <p><b>WARNUNG Missachtung nachfolgender Punkte kann einen elektrischen Schlag, Brände, schwere Unfälle oder Tod zur Folge haben:</b></p> <ul style="list-style-type: none"> <li>- Schalten Sie die Eingangsspannung vor Installations-, Wartungs- oder Änderungsarbeiten ab und sichern Sie diese gegen unbeabsichtigtes Wiedereinschalten.</li> <li>- Führen Sie keine Änderungen oder Reparaturversuche am Gerät durch. Gerät nicht öffnen!</li> <li>- Verhindern Sie das Eindringen von Fremdkörpern, wie z.B. Büroklammern und Metallteilen.</li> <li>- Betreiben Sie das Gerät nicht in feuchter Umgebung oder in einer Umgebung, bei der mit Betauung oder Kondensation zu rechnen ist.</li> <li>- Gehäuse nicht während des Betriebes oder kurz nach dem Abschalten berühren. Heiße Oberflächen können Verletzungen verursachen.</li> </ul>
<p><b>Français Instruction d'installation</b></p>	<p><b>A lire avant mise sous tension!</b> Veuillez lire ces instructions de montage et d'entretien avant de mettre l'alimentation sous tension. Conservez ce manuel qui vous sera toujours utile. Cette alimentation ne doit être installée que par du personnel qualifié et compétent. En cas de dommage ou dysfonctionnement, coupez immédiatement la tension d'alimentation et retournez l'appareil à l'usine pour vérification! L'alimentation ne contient pas de pièces échangeables Les données indiquées dans ce document servent uniquement à donner une description du produit et n'ont aucune valeur juridique. En cas de divergences, le texte anglais fait foi.</p> <p><b>AVERTISSEMENT Prendre en compte les points suivants, afin d'éviter toute détérioration électrique, incendie, dommage aux personnes ou mort:</b></p> <ul style="list-style-type: none"> <li>- Mettre l'alimentation hors tension avant toute intervention sur celle-ci et s'assurer qu'il n'y a pas risque de redémarrage.</li> <li>- Ne pas ouvrir, modifier ou réparer l'alimentation.</li> <li>- Veiller à ce qu'aucun objet ne rentre en contact avec l'intérieur de l'alimentation (trombones, pièces métalliques).</li> <li>- Ne pas faire fonctionner l'appareil dans un environnement humide ou dans un environnement où il peut y avoir de la condensation.</li> <li>- Ne pas toucher le carter pendant le fonctionnement ou directement après la mise hors tension. Surface chaude risquant d'entraîner des blessures.</li> </ul>
<p><b>Español Instrucciones de instalación</b></p>	<p><b>Lea primero!</b> Conserve este manual como referencia para futuras consultas. La fuente de alimentación solo puede ser instalada y puesta en funcionamiento por personal cualificado. Por favor lea detenidamente este manual antes de conectar la fuente de alimentación. Si se produce un fallo o mal funcionamiento durante la operación, desconecte inmediatamente la tensión de alimentación. En ambos casos, el equipo debe ser inspeccionado en fábrica. La información presentada en este documento es exacta y fiable en cuanto a la descripción del producto y puede cambiar sin aviso. En casa de duda, prevalece el texto inglés.</p> <p><b>ADVERTENCIA Riesgo de descarga eléctrica, incendio, accidente grave o muerte:</b></p> <ul style="list-style-type: none"> <li>- Desconectar la tensión de red antes de trabajar en la fuente de alimentación. Evite una posible reconexión involuntaria.</li> <li>- No realizar ninguna modificación o reparación de la unidad. No abrir la unidad.</li> <li>- Evitar la introducción en la carcasa de objetos extraños.</li> <li>- No usar el equipo en ambientes húmedos. No operar el equipo en ambientes donde se espere la formación de rocío o condensación.</li> <li>- No tocar durante el funcionamiento ni inmediatamente después del apagado. El calor de la superficie puede causar quemaduras graves.</li> </ul>
<p><b>Italiano Istruzioni di Installazione</b></p>	<p><b>Leggere prima questa parte!</b> Prima di collegare il sistema di alimentazione elettrica si prega di leggere attentamente le seguenti avvertenze. Conservare le istruzioni per la consultazione futura. Il sistema di alimentazione elettrica deve essere installato solo da personale competente e qualificato. Se durante il funzionamento si verificano anomalie o guasti, scollegare immediatamente la tensione di alimentazione. In entrambi i casi è necessario far controllare l'apparecchio dal produttore! I dati sono indicati solo a scopo descrittivo del prodotto e non vanno considerati come caratteristiche garantite dell'apparecchio. In caso di differenze o problemi è valido il testo inglese.</p> <p><b>AVVERTENZA Il mancato rispetto delle seguenti norme può provocare folgorazione elettrica, incendi, gravi incidenti e perfino la morte:</b></p> <p>Prima di eseguire interventi di installazione, di manutenzione o di modifica scollegare la tensione di rete ed adottare tutti i provvedimenti necessari per impedirne il ricollegamento non intenzionale.</p> <ul style="list-style-type: none"> <li>- Non tentare di aprire, di modificare o di riparare da soli l'apparecchio.</li> <li>- Impedire la penetrazione di corpi estranei nell'apparecchio, ad esempio fermagli o altri oggetti metallici.</li> <li>- Non far funzionare l'apparecchio in un ambiente umido. Non far funzionare l'apparecchio in un ambiente soggetto alla formazione di condensa o di rugiada.</li> <li>- Non toccare quando acceso e subito dopo lo spegnimento. La superficie calda può causare scottature.</li> </ul>
<p><b>Português Instruções de instalação</b></p>	<p><b>Leia primeiro!</b> Recomendamos a leitura cuidadosa das seguintes advertências e observações, antes de colocar em funcionamento a fonte de alimentação. Guarde as Instruções para futura consulta, em casos de dúvida. A fonte de alimentação deverá ser instalada apenas por profissionais da área, tecnicamente qualificados. Se por acaso, durante a utilização ocorrer algum defeito de funcionamento ou dano, desligue imediatamente a tensão de alimentação. Em ambos os casos, será necessária uma verificação na Fábrica! Os dados mencionados têm como finalidade somente a descrição do produto, e não devem ser interpretados como propriedades garantidas no sentido jurídico. Em caso de dúvidas aplica-se o texto em inglês.</p> <p><b>ATENÇÃO A não observância ou o incumprimento dos pontos a seguir mencionados, poderá causar uma descarga elétrica, incêndios, acidentes graves ou morte:</b></p> <p>Antes de trabalhos de instalação, manutenção ou modificação, desligue a tensão de alimentação, protegendo-a contra uma nova ligação involuntária.</p> <ul style="list-style-type: none"> <li>- Não efectue nenhuma modificação ou tentativa de reparação no aparelho. Quando necessário contacte o seu distribuidor. Não abra o aparelho.</li> <li>- Proteger a fonte de alimentação contra a introdução inadvertida de corpos metálicos, como por ex., cliques ou outras peças de metal.</li> <li>- Não usar o aparelho em ambientes húmidos. Não usar o aparelho em ambientes propensos a condensações.</li> <li>- Não tocar enquanto estiver em funcionamento, nem após a desligar. A superfície poderá estar quente e provocar lesões.</li> </ul>